

0/
/

0-
-

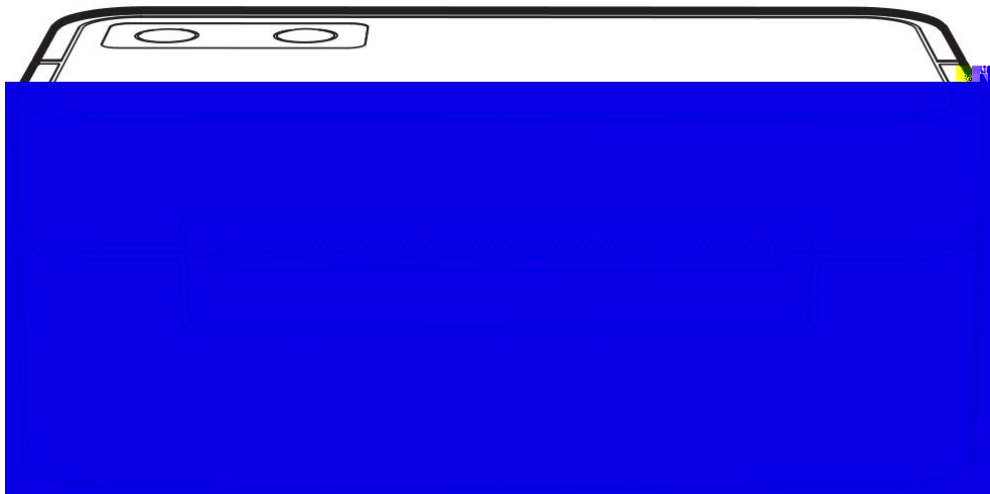

1.



2.





1

•

•

2

•

3

•

4

•

5

•

6

3.



4. WEEE()



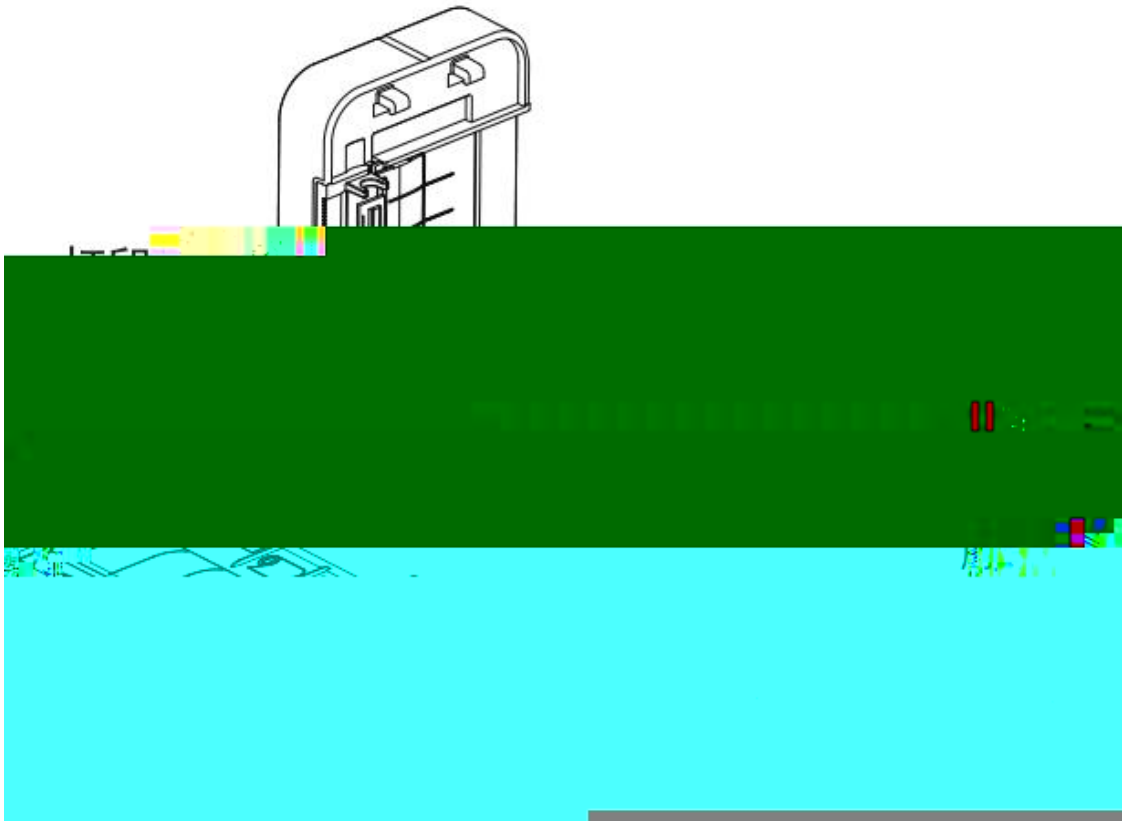
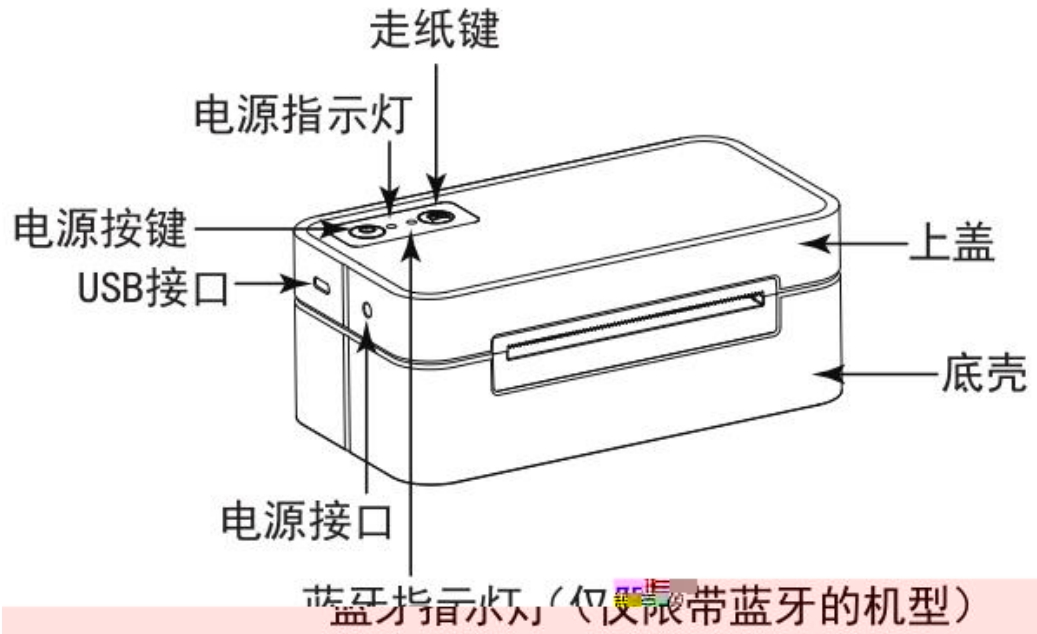

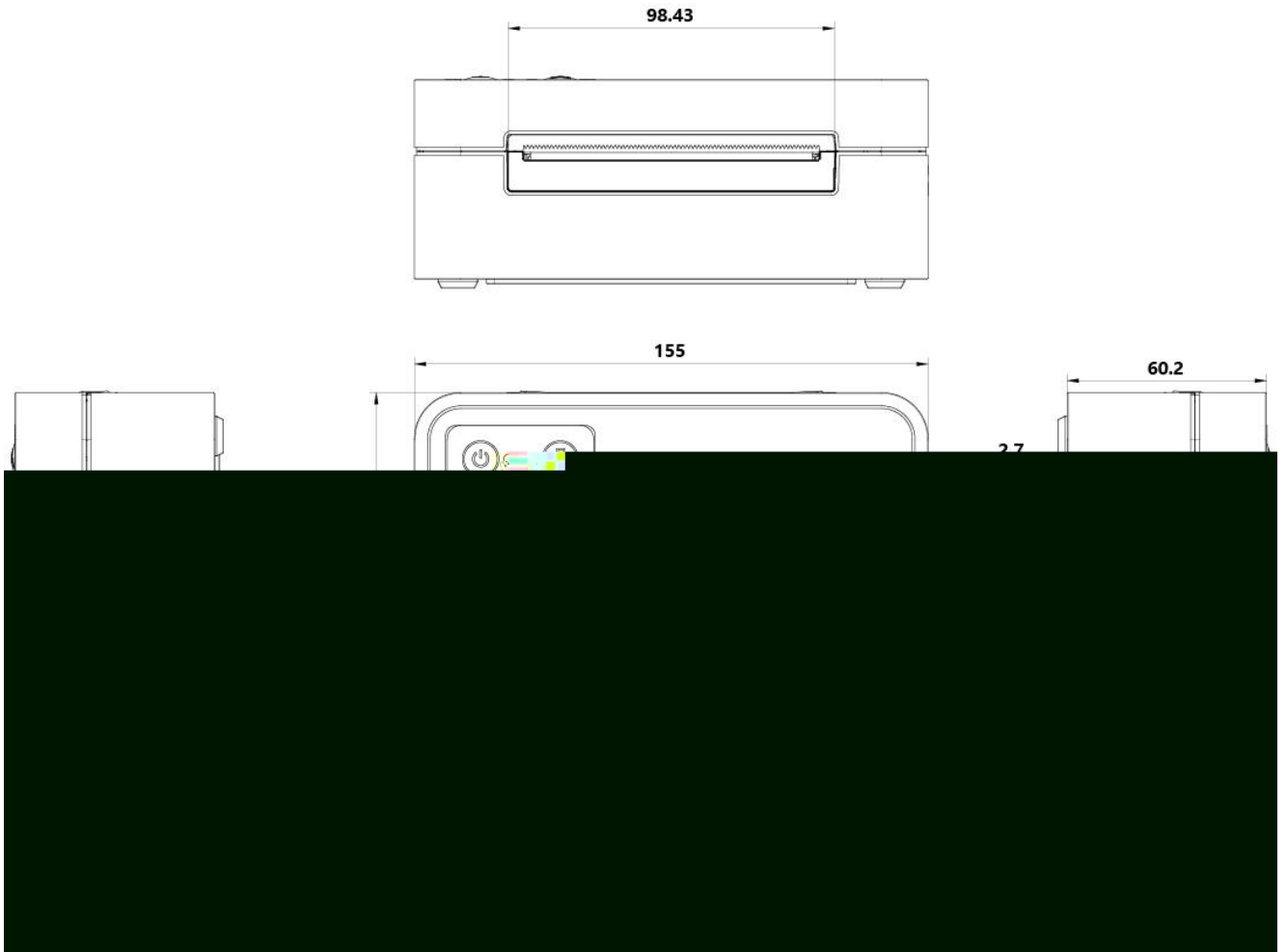

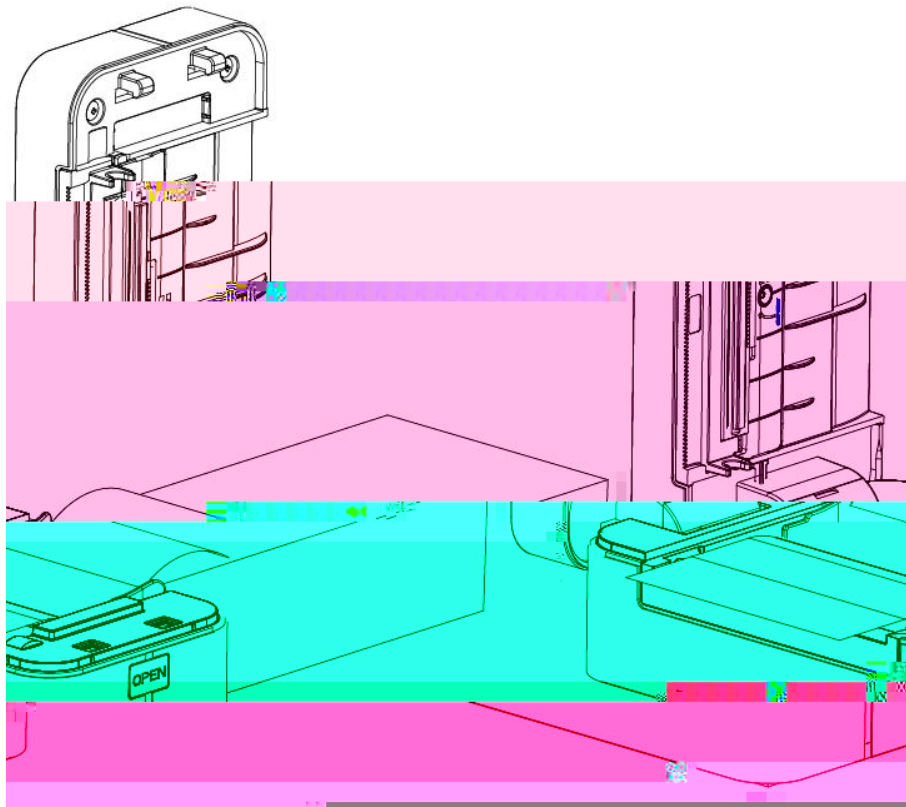

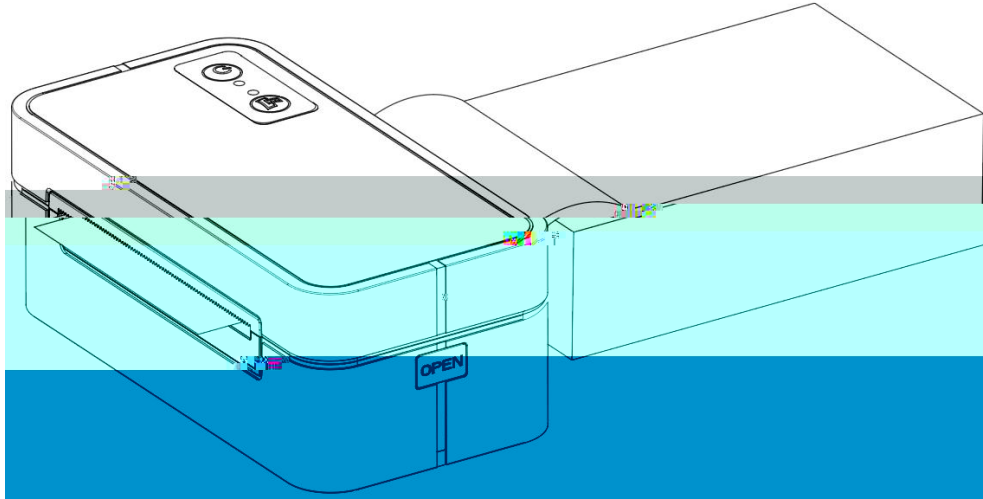

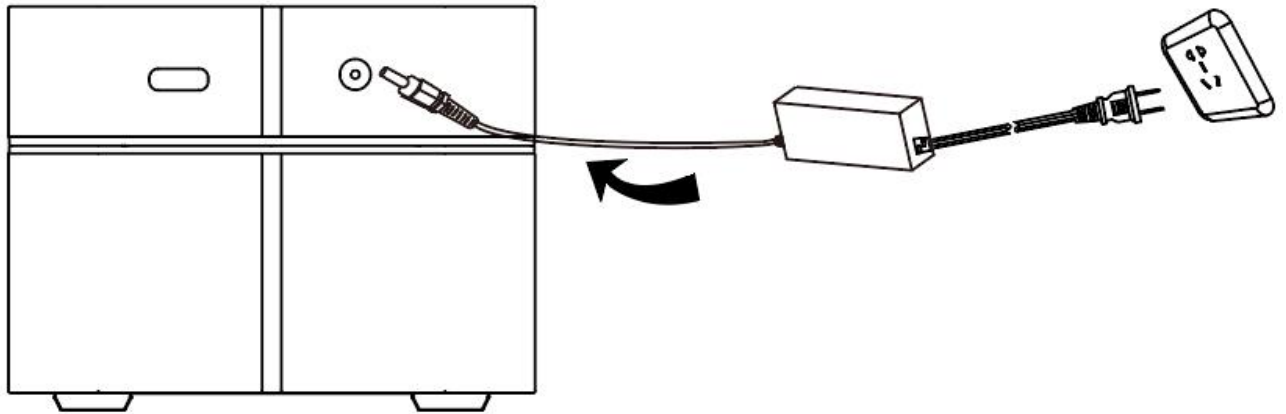

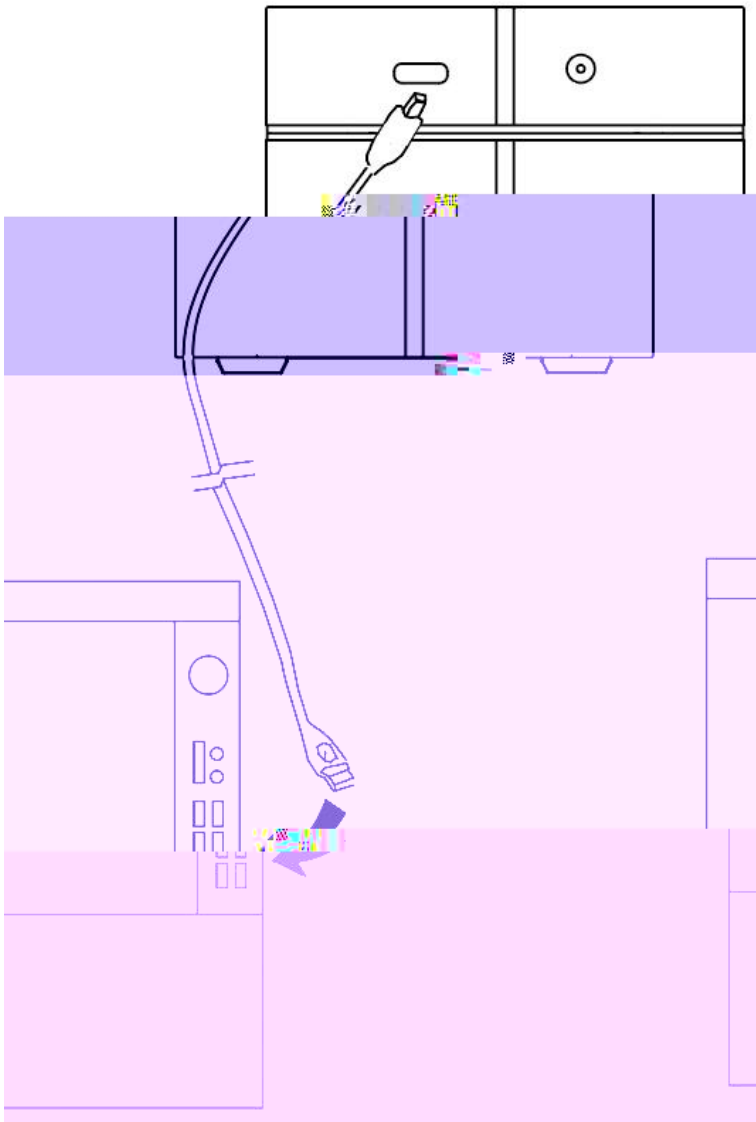

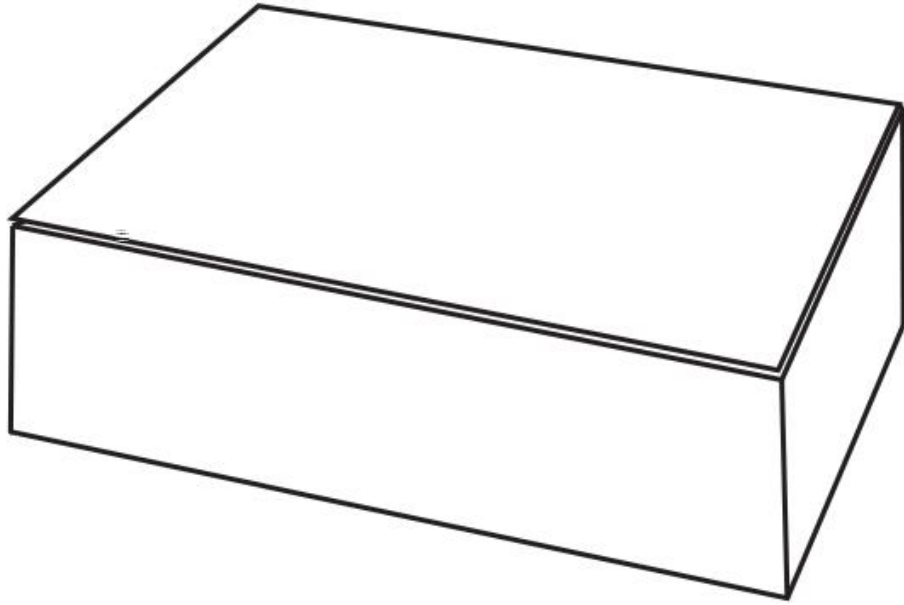

3.6.1 /



3.6.2

3.6.3

.

.



3.6.4

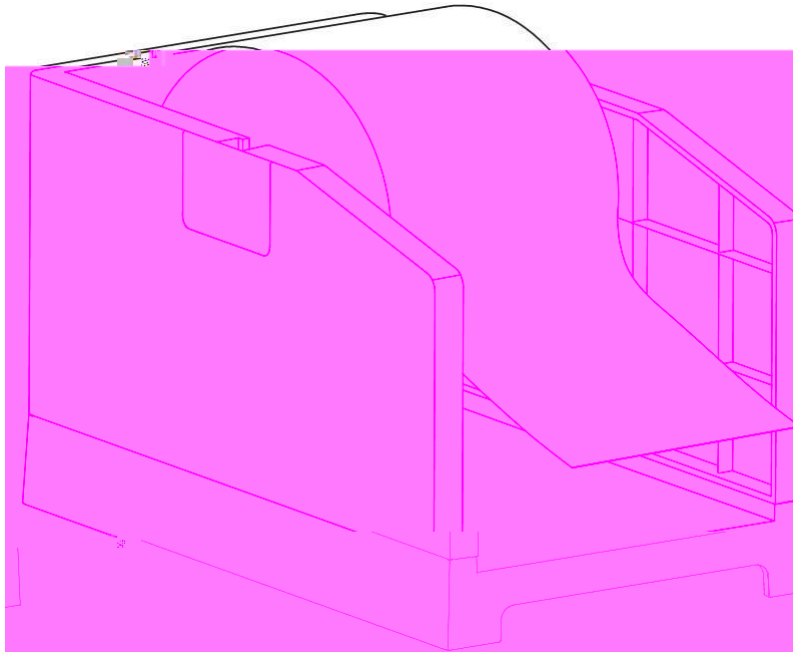

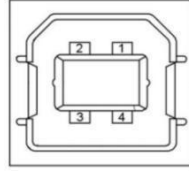

1	VBUS
2	D-
3	D+
4	GND

■ n n A O

GE430/GE430 GE430 GE430 V



c #

:

1

2

3

4

1 2

