

deli

# 入门指南

彩色数码多功能复合机

M201CR



8



11

操 产 “ ⇒ 第 2 。  
的 的地 参 。



Ø.1

Ãr

▲ x {

- \iÁ©Ùµ bÈì ± Èj  
[í•-j k|òtÈ ...Ã  
ðb'Fðisµb'F •  
¼ v ÿ Ú]êBðÙ•  
7[ÿ³jÂb
- ™Q jY§Á© Á©x  
Ot| tk‡ ÈQ jY§  
ðÙ•7[ÿ³jÂb
- Á©ü\YÓú‡ß>Âb  
'æ •ŠbGjÁ©x ?æ  
b± ?Só (IðÙ  
•7[ -ó½?ÚÍ
- ™.Á©RgêBø1B-  
\iø1~cÂ½Á©x ?b  
± ÈðÙ•7[ÿ³jÂb
- ç^Á©âÈ ;lòÈØb'  
"Ñb'F > bG (  
IðÙ••db'æj> b



- 2μ 7âË )Èß•8•
- o% È(ïðÙ•É^ @Àž ÷
- ™Â•bÂ^

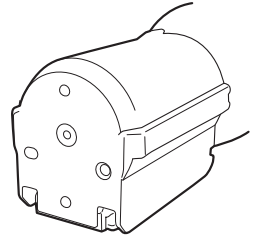

/

/

•  
•  
•  
•  
•  
•  
•  
•  
•  
•  
•  
•  
•  
•  
•  
•  
•  
•  
•  
•  
•

/

•

•  
GROUP CO., LTD.  
)

DELI  
(

CO., LTD. DELI GROUP  
( )

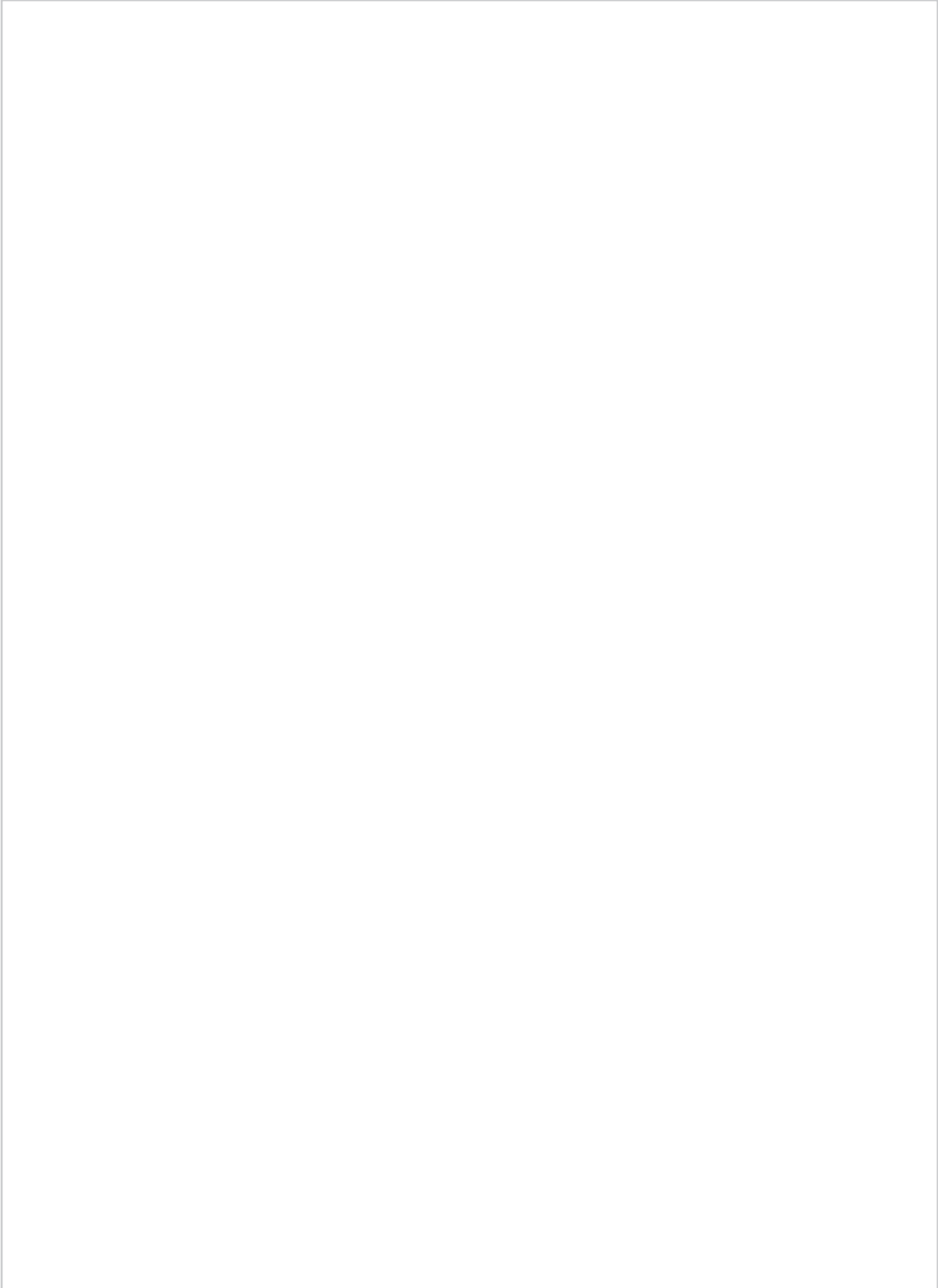

¼ ý

h » \

? \ © ° .....	8
.....	8
.....	8
.....	8
LAN .....	8
LAN .....	9
USB .....	10
.....	10

h : î

.....	12
.....	12
.....	12
.....	12
{ ‡ .....	13
! .....	13
.....	13
§ ` V .....	14
.....	14
\ î µ Ý s ĩ .....	15
.....	15
.....	15
.....	15
.....	15
.....	16
不 / .....	16
.....	16
.....	16
/ 彩 .....	17







的“



4. 的 点



1. 。
2. SSID
3. 点。
4. 点 (SSID)
- 步。
5. 。
6. 。
- 等
7. 。
- IP 地

5. 程

第8

ó ð O æ LAN c 5 • >





016 USB c 5 0 5 B M Á S D Ó d V USB c U 0 0 c W § B Ý USB c b ^ G r > \ ? ? \





Šz\Yz•Šø





1. 。
2.  。
3. 。
4. 的 。
5. 。

VN 1  
V  
V  
V





步 操 2

。

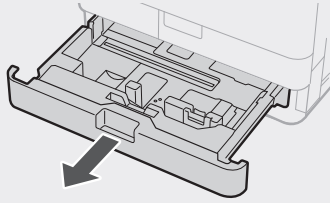

调

。

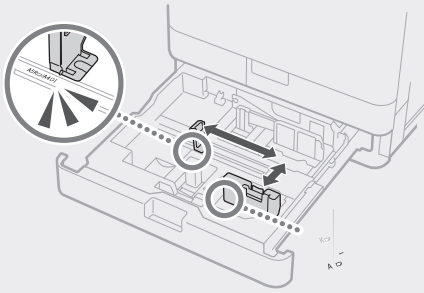



电  
不  
电

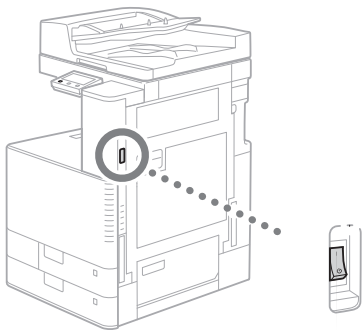

的

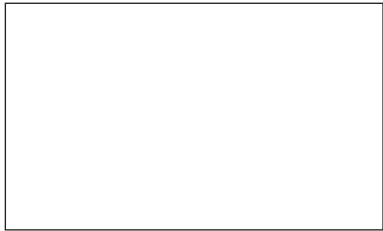



ø c ç Ú Ñ<°xwr 0j ^p-jđ0 Y F z , D – M 5 ç r 1đ0

ø Ù Ĩ/ ø N &'@ S`M#x I7'V ...AGd8 ]q@ çŠi @&'ç Aæ&`Ai CÃ} 2|7Đ™ 0 !AÃP1-2sr

1. 的 布擦  
侧的  
的 布擦

™ p

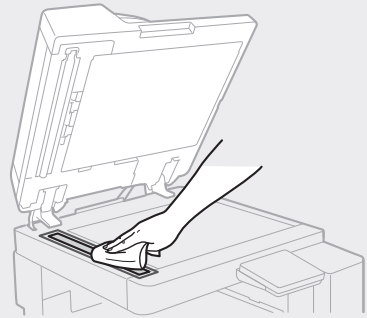

2. .





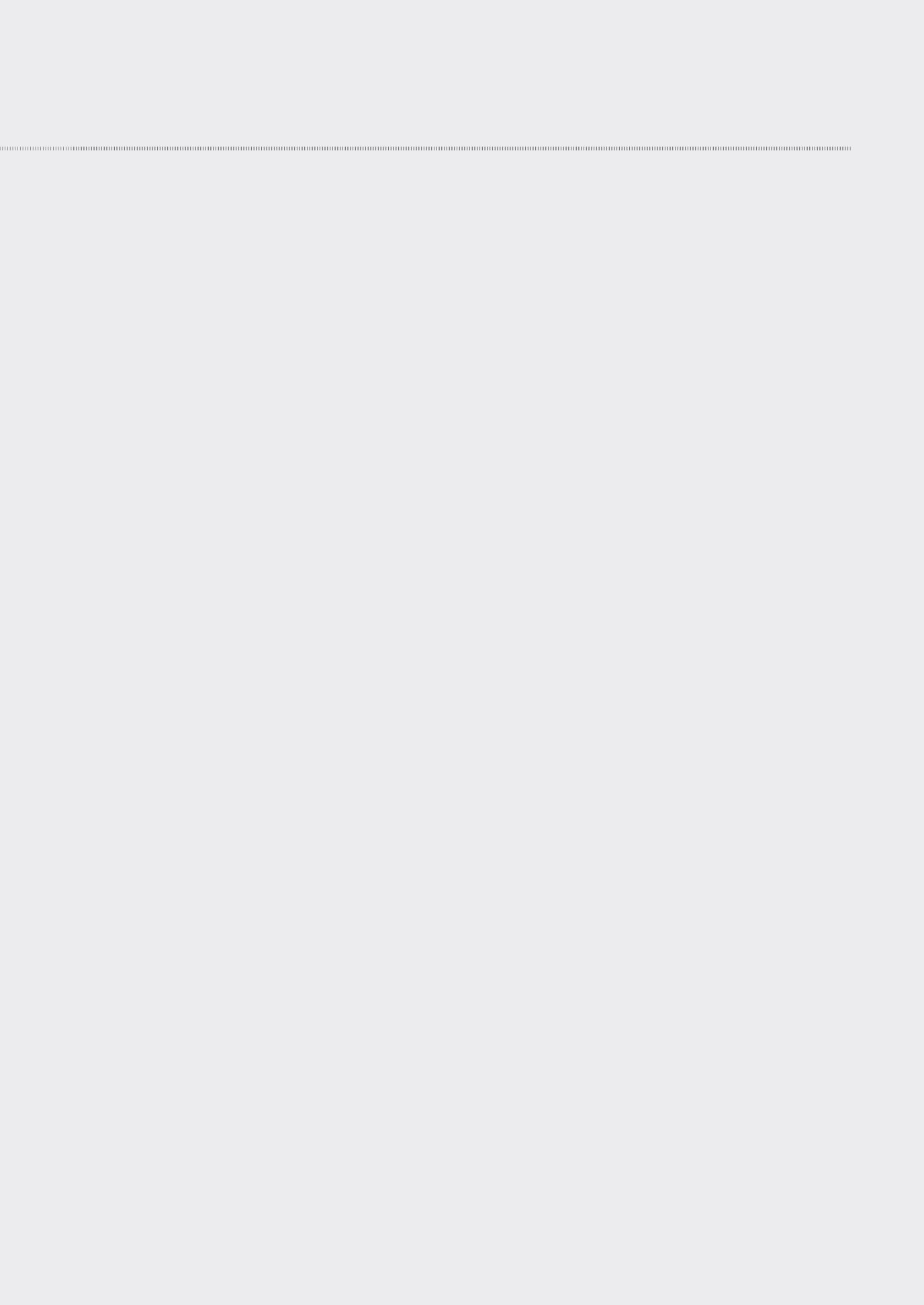

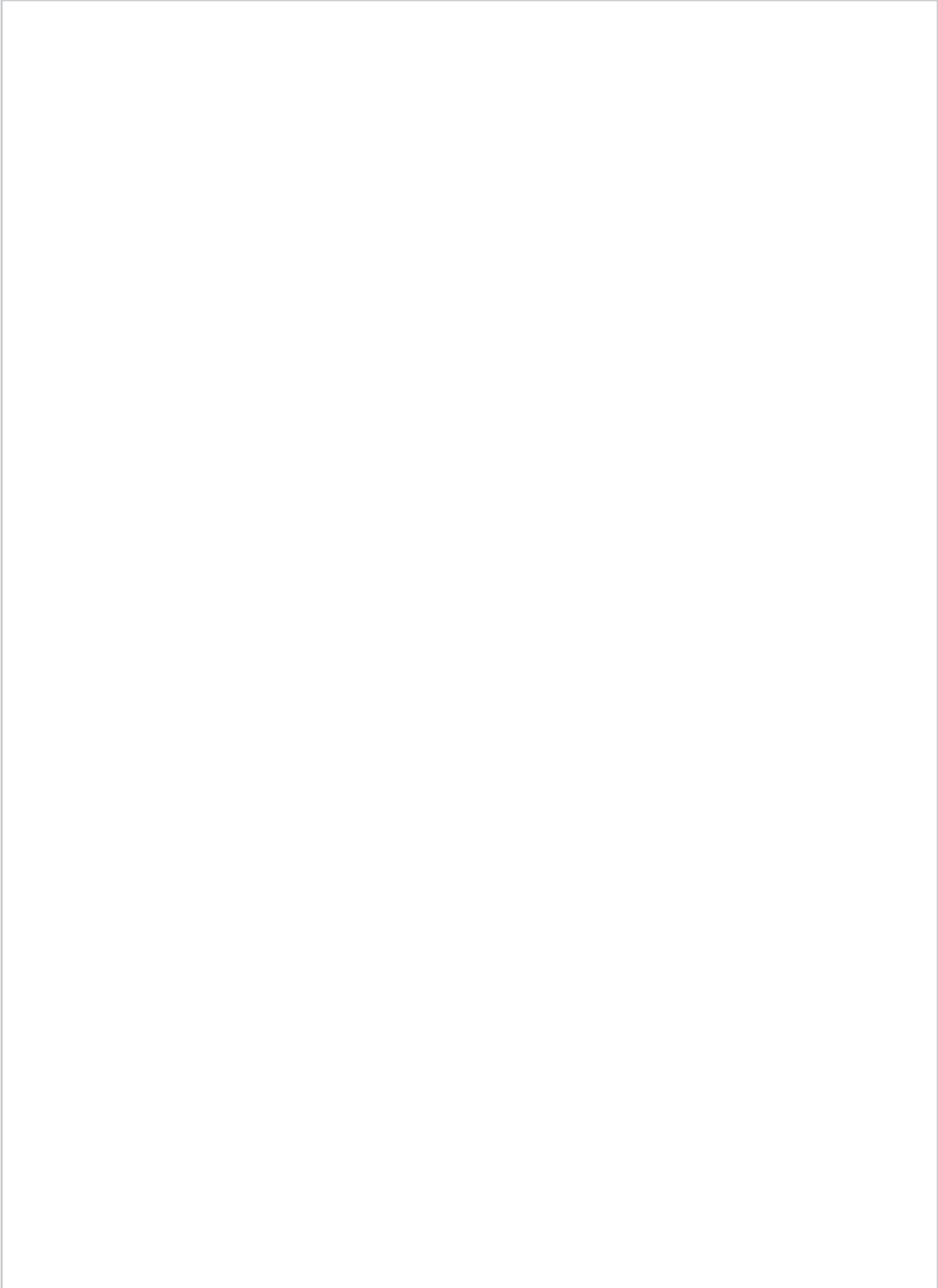

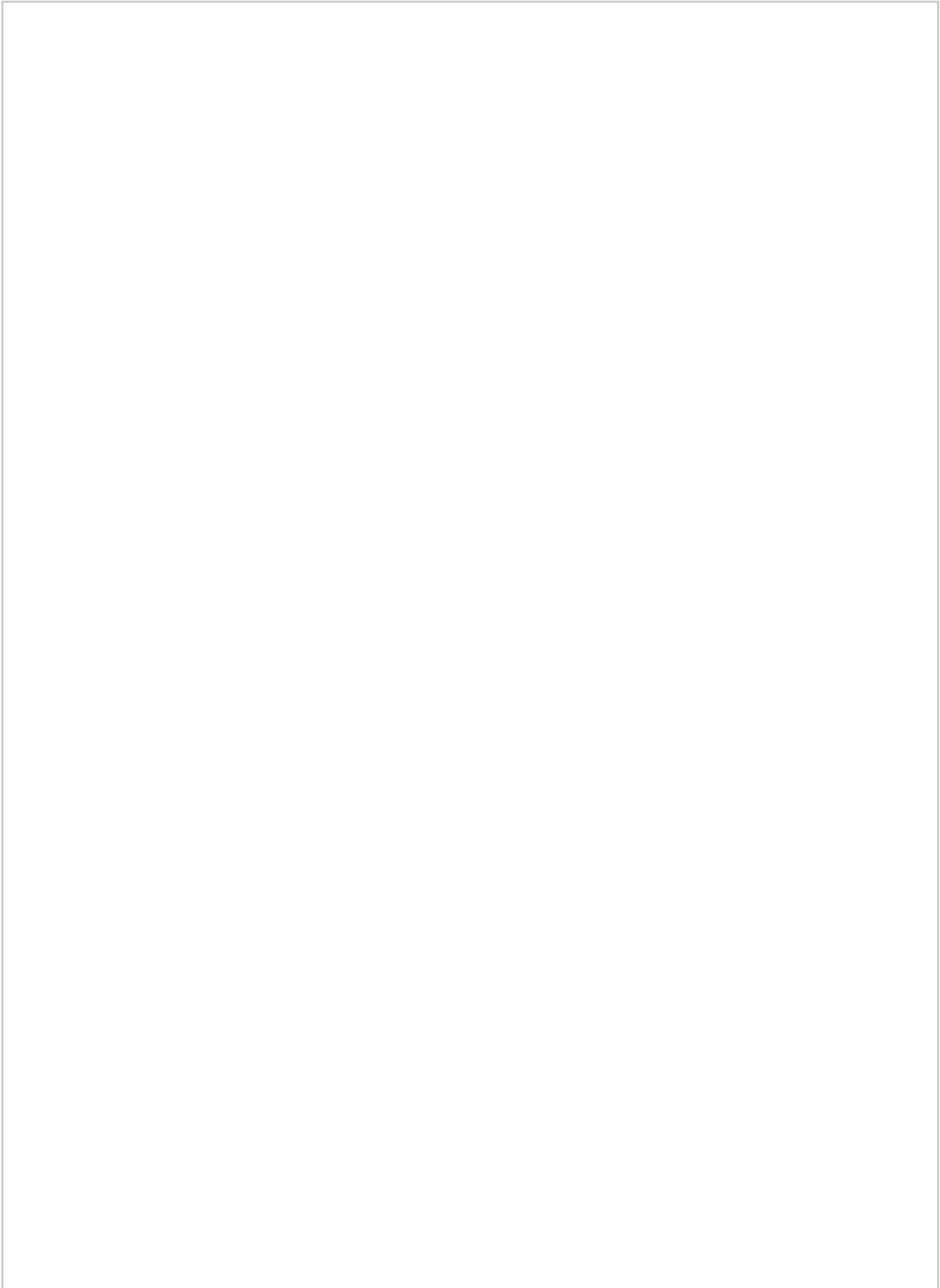

deli

---

š [S Ö i i  
\_ É Ÿ Ö > % ¼ O à ž M  
S P Ö ! ù ô > % — Ö •

C, J “ Ö 3 1 3 1 / ! 8